

FURITEK LIZARD PRO 30A/50A BRUSHED/BRUSHLESS ESC FOR AXIAL SCX24 WITH FOC TECHNOLOGY

Features:

- Support sensorless brushless DC and brushed DC motor (config via app, default is brushless)
- FOC (Field-oriented control) technology
- Plug & Play designed for AXIAL SCX24 crawlers
- 5V/ 6.5V 2.5A Built-in BEC (config via app)
- Support 2S-3S lipo battery - Mini size and lightweight
- Super easy programming via App on both Android and IOS
- Firmware update available (Bluetooth module required)
- Real-time telemetry up to 10Hz - Ability to run with stock TX/RX or any other TX/RX

Specifications:

- Support 2S-3S lipo battery
- BIG BEC: 5V or 6.5V 2.5A (Don't need external BEC if use big Servo)
- Constant current: 30A
- Burst current: 50A
- Built-in power switch
- Dimension (mm): 28(L)x 15.5(W)
- Weight: 3.7 grams

Pinout:

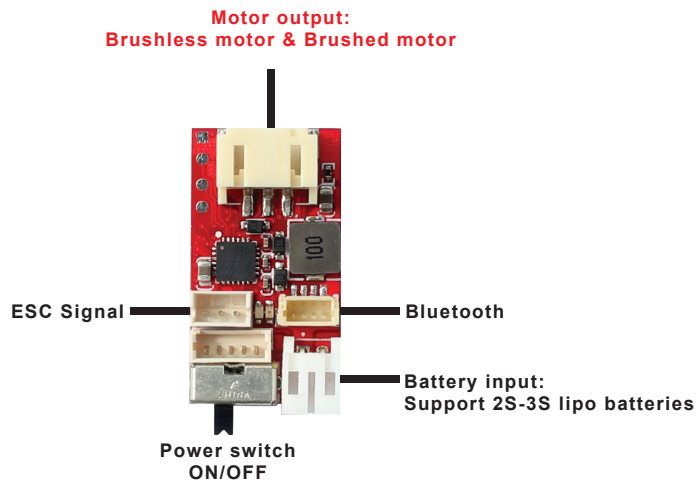

Connect Brushed/Brushless motor to ESC:

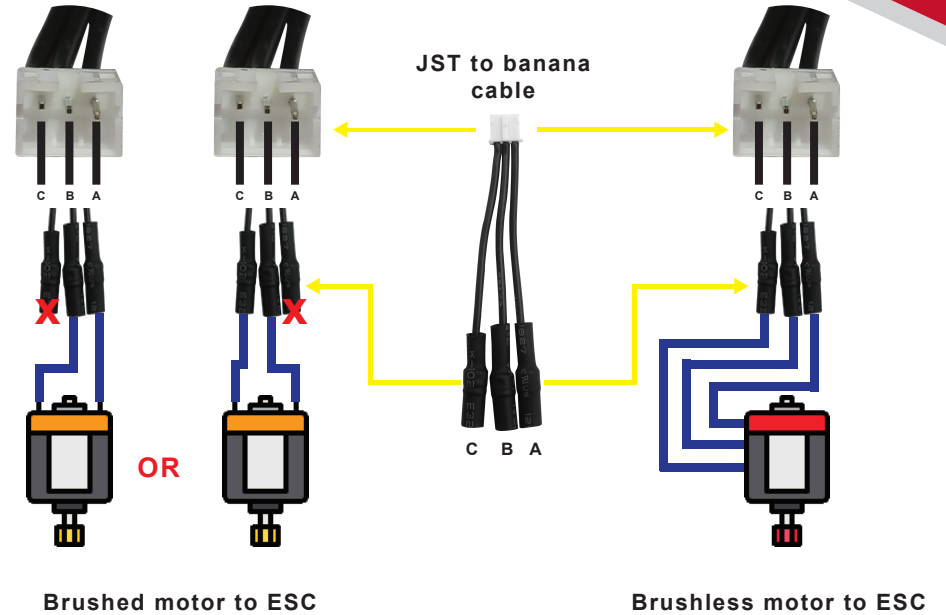

***DEFAULT configuration is Brushless motor, if you use BRUSHED motor, please configure it as below:**

- Step 1: Please make sure to plug your battery to esc and open FURICAR app on android or IOS device
- Step 2: Please Click the Setting icon (see picture)
- Step 3: Please click "Motor Type" menu, a new window pops up, select "Brushless" or "Brushed" and then click "OK"

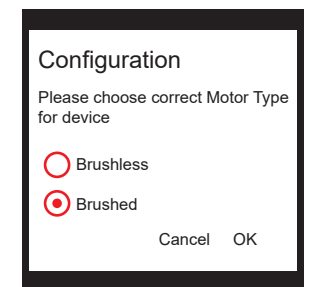
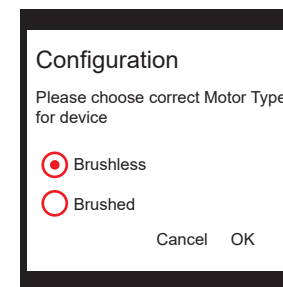
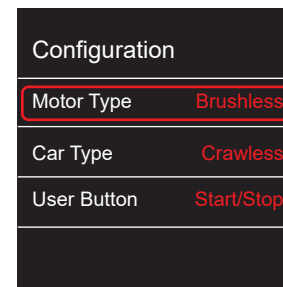

Esc Manual calibration:

A. Calibration on ESC Mainboard:

- **Step 1:** Turn on your radio and move your radio throttle stick **FORWARD** or throttle stick **BACKWARD**
- **Step 2:** Plug the battery to your esc (The ESC LED indicator will start blinking followed by a motor beeping sound) and then ESC LED indicator will blink 4 time and motor will beep 4 time)
- **Step 3:** Set to 0% Throttle or lowest speed (please make sure that your radio throttle stick at **NEUTRAL POSITION**, ESC LED indicator will blink 1 time and motor will beep 1 time)
- **Step 4:** Set to 100% Throttle or Maximum speed (move your radio throttle stick **FORWARD** and ESC LED indicator will blink 2 times and motor will beeps 2 times)
- **Step 5:** Setting up of your BRAKE (move the radio throttle stick **BACKWARD** and ESC LED indicator will blink 3 times and motor will beep 3 times)
- **Step 6:** When the LED light on your ESC blinks 4 times and the motor beeps 4 times, you have successfully calibrated your Furitek esc

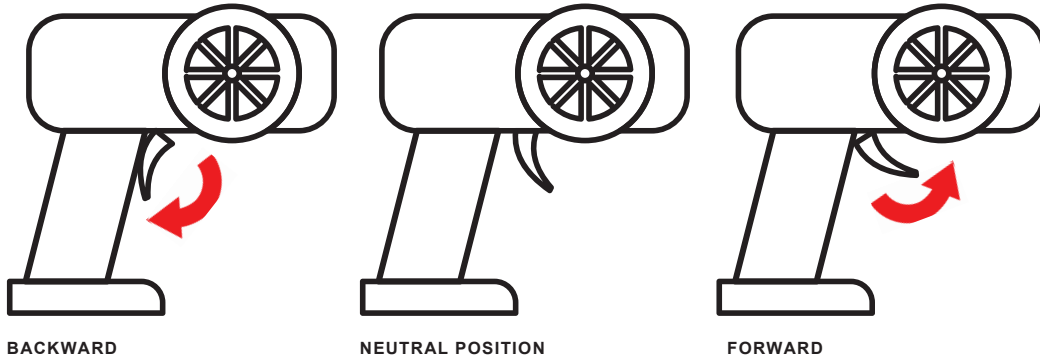

B. Calibration via App: (Your esc need a Bluetooth to communicate with app)

- **Step 1:** Please make sure to plug your battery to esc and open FURICAR app on android or IOS device
- **Step 2:** Please click "MENU" and click "THROTTLE"

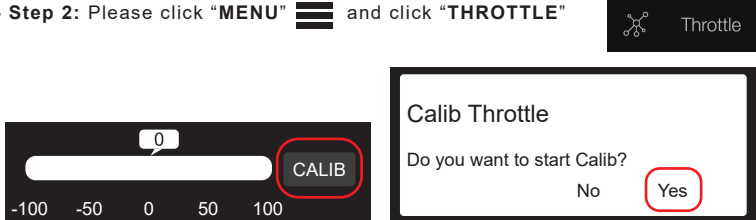

*Follow intructions on the app screen till finish calibration

Bluetooth:

- Default password to connect to the bluetooth is "1234"

*Change password:

- **Step 1:** Please make sure to plug your battery to esc and open FURICAR app on android or IOS device
- **Step 2:** Please Click the Setting icon (see picture)
- **Step 3:** Please Click "Change Password" menu, a new window pops up, type your new password and then click "OK"

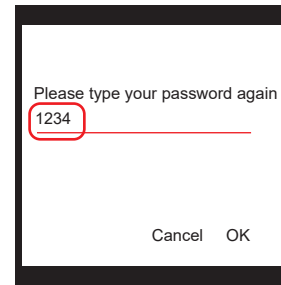

Default password: 1234

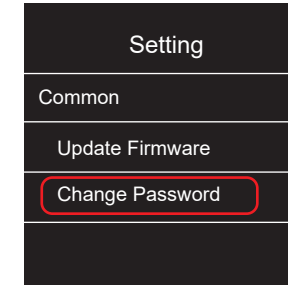

Change password

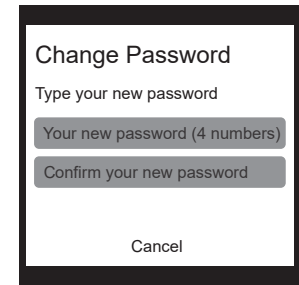

Change Output voltage:

(Warning: High Voltage might kill your servo, make sure your servo can work with high voltage)

- **Step 1:** Please make sure to plug your battery to esc and open FURICAR app on android or IOS device
- **Step 2:** Please click "Menu" and click "Running"
- **Step 3:** Please click "Output voltage" and then select "5V or 6.5V"

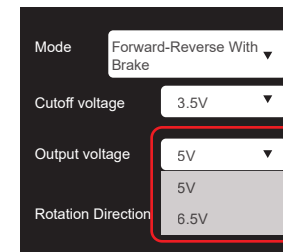

Note: Output voltage "6.5V" led on main Esc always on when active
Output voltage "5V" led on main Esc off when active